

Fuel Cards

## Fuel Cards

### Fuel Level Sender Application

The fuel level in automotive applications is typically measured by a float and lever arm assembly that operates a variable resistor mechanism. In many cases, this assembly (known as a fuel sender or fuel level sender) is mounted in the fuel tank and integrated into the fuel delivery module. This module removes fuel from the tank and delivers pressurized fuel to the power train.

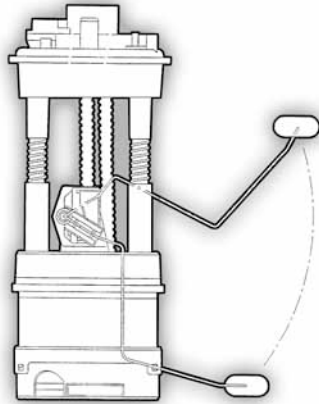

Figure 1: Fuel delivery module

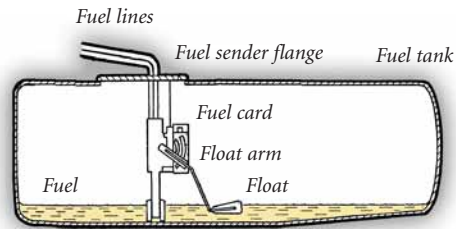

Figure 2: Fuel level sender mounted in fuel tank

### Fuel Level Sender Design & Construction

The variable resistor mechanism is comprised of a wiper and a resistor element printed on a ceramic substrate. The resistor element (also known as a fuel card) is mounted close to the pivot point of the float arm, which is attached to the wiper. As the float rises and falls with the fuel level, the wiper moves in a rotary motion across the tracks on the resistor element, translating the float position into a resistance value. This is converted into a voltage or current signal driving the indication system in the dashboard. Less common are linear type fuel level senders where a float moves within a tube, translating the fuel level into a linear wiper movement. This type of fuel level sender is mainly used in space-constrained tanks, as in motor-cycles and scooters.

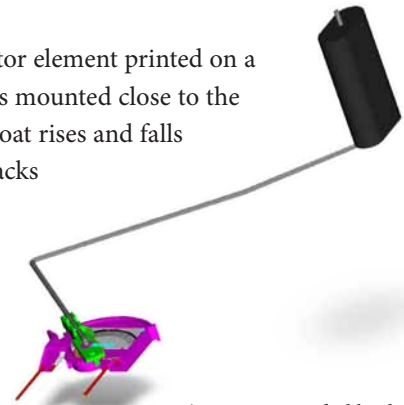

Figure 3: Bourns fuel level sender

Most car models have custom designed fuel tanks, where the tank is molded to fit around other components and body frames. There is an increasing trend to use a more complex blow-molded plastic tank versus the traditional steel tank. On rear wheel drive and four wheel drive vehicles, a saddle tank is often used, where the two halves of the fuel tank straddle the rear drive shaft. These complex fuel tank geometries require specific fuel card resistor profiles so that the translation of the float height gives the appropriate fuel volume signal to the fuel gauge. For this reason, a custom fuel card is generally designed for each fuel tank model.

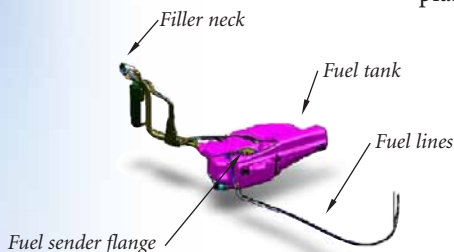
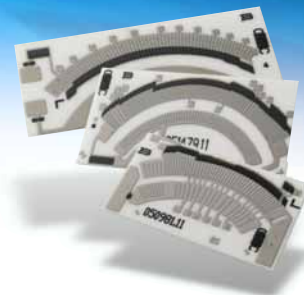

Figure 4: Overview of automotive fuel storage & delivery system

# APPLICATION NOTE



Fuel Cards

The first fuel senders were wirewound construction. However, in many instances these units suffered from wire wear and breakages. The resistance profile of the wirewound fuel sender also changed as the wire wore at different rates and positions of the float arm. These problems were overcome with the introduction of the thick film fuel card. A variable resistor is achieved by tapping the resistor traces with segmented conductor tracks creating a step-function output as shown in Figure 6. If the wiper contact were to run directly on the cermet resistor, as in a potentiometer, the required product life specification of at least 1 million wet cycles would not be achieved. A tight resistance tolerance of each partial resistor is achieved by laser trimming.

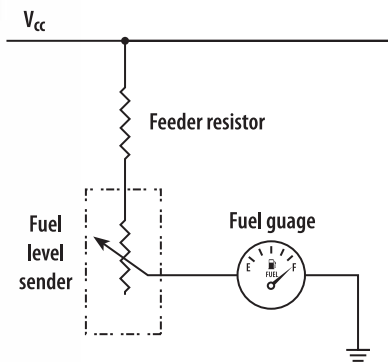

Figure 5: Typical fuel level indication circuit

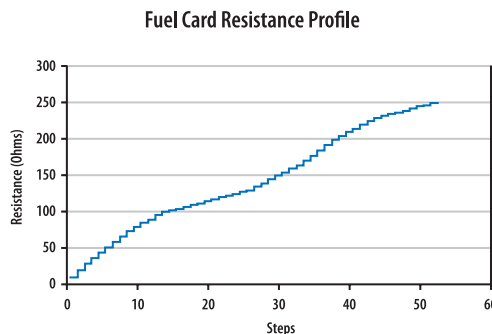

Figure 6: Example of step-function output

As the fuel card (resistor element) is immersed in fuel, its chemical resistance is of great importance. The introduction of low-sulphur fuels for environmental reasons has placed additional demands on conductor metallurgies.

## Typical fuel card designs

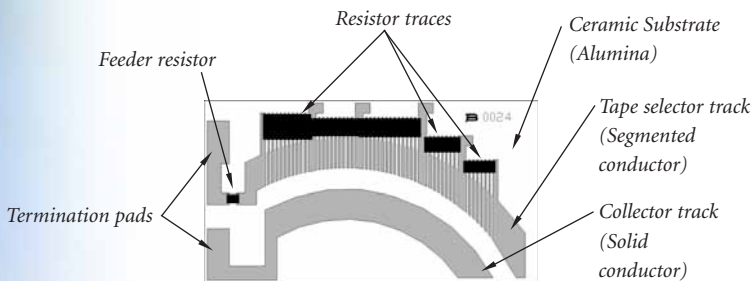

Figure 7: Fuel card design overview (Dual track design)

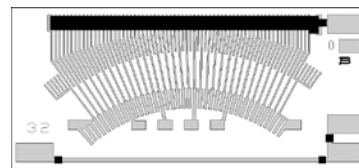

Figure 8: Dual track design

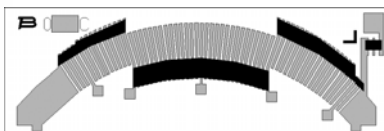

Figure 9: Single track design

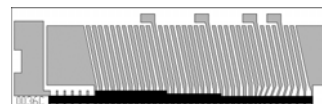
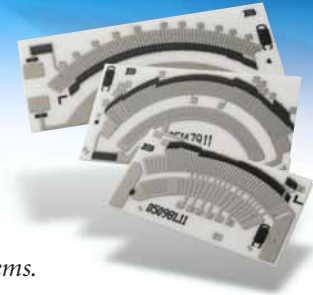

Figure 10: Linear track design



Fuel Cards

## **Trends in the fuel level sender market**

- Increased fuel sender accuracy and resolution requirements due to increased integration of dashboard electronics and driver information systems.
  - ☑ Bourns is currently shipping fuel cards with up to 100 discrete resistance steps
- Increased chemical resistance: The major driver for increased chemical resistance is driven by the introduction of low-sulphur fuels, particularly in the US market. These fuels may contain reactive sulphur compounds, which react with traditional palladium silver conductor inks.
  - ☑ Bourns offers a range of materials to meet this requirement, from increased palladium content inks to “silver free” gold inks
- Increased product integration: An increasing number of customers are now requesting higher levels of product integration.
  - ☑ Bourns offers fuel cards with leads attached, tinned pads and wiper contacts

## **The Bourns Competitive Advantage**

- Dedicated fuel card design and sample team for rapid sample turnaround
- Full fuel sender design capability
- Active fuel sender R&D program with several patents issued or pending
- Extensive corporate material science expertise and R&D facilities
- Internally developed, state of the art, thick film print capability with outstanding print registration and in-line ink thickness measurement.
- Competitive pricing for best cost/life benefit
- High volume manufacturing
- Manufacturing location QS9000 certified and TS16949 planned for 2004
- Superior product quality through 100% end-of-line dynamic testing
- Extensive production experience in gold fuel cards for low-sulphur fuel applications
- Superior, vision assisted, laser trim capability

Please contact your local Bourns Sales Representative for more information.

**Europe:** Tel +49-(0) 8104 646-0  
Fax +49-(0) 8104 646-803

**Americas:** Tel +1-(0) 248 926-4088  
Fax +1-(0) 248 926-1718