



Features

- RoHS compliant*
- Surface Mount SMB package
- Standoff Voltage: 5.0 to 170 volts
- Power Dissipation: 600 watts

Applications

- IEC 61000-4-2 ESD (Min. Level 4)
- IEC 61000-4-4 EFT
- IEC 61000-4-5 Surge

SMBJ Transient Voltage Suppressor Diode Series

General Information

The markets of portable communications, computing and video equipment are challenging the semiconductor industry to develop increasingly smaller electronic components.

Bourns offers Transient Voltage Suppressor Diodes for surge and ESD protection applications, in compact chip package DO-214AA (SMB) size format. The Transient Voltage Suppressor series offers a choice of Working Peak Reverse Voltage from 5 V up to 170 V and Breakdown Voltage up to 200 V. Typical fast response times are less than 1.0 ns for unidirectional devices and less than 5.0 ns for bidirectional devices from 0 V to Minimum Breakdown Voltage.

Bourns® Chip Diodes conform to JEDEC standards, are easy to handle with standard pick and place equipment and the flat configuration minimizes roll away.

Electrical Characteristics (@ T_A = 25 °C Unless Otherwise Noted)

Parameter	Symbol	Value	Unit
Minimum Peak Pulse Power Dissipation (T _p = 1 ms) (Note 1,2)	P _{PK}	600	Watts
Peak Forward Surge Current 8.3 ms Single Half Sine Wave Superimposed on Rated Load (JEDEC Method) (Note 3)	I _{FSM}	100	Amps
Steady State Power Dissipation @ T _L = 75 °C	P _{M(AV)}	5.0	Watts
Maximum Instantaneous Forward Voltage @ I _{PP} = 50 A (For Unidirectional Units Only)	V _F	(Note 5)	Volts
Operating Temperature Range	T _J	-55 to +150	°C
Storage Temperature Range	T _{STG}	-55 to +175	°C

1. Non-repetitive current pulse, per Pulse Waveform graph and derated above T_A = 25 °C per Pulse Derating Curve.
2. Thermal Resistance Junction to Lead.
3. 8.3 ms Single Half-Sine Wave duty cycle = 4 pulses maximum per minute (unidirectional units only).
4. Single Phase, Half Wave, 60 Hz, resistive or inductive load. For capacitive load, derate current by 20 %.
5. V_F = 3.5 V on SMBJ5.0A through SMBJ90A and V_F = 5.0 V on SMBJ100A through SMBJ170A.



Asia-Pacific:

Tel: +886-2 2562-4117 • Fax: +886-2 2562-4116

Europe:

Tel: +41-41 768 5555 • Fax: +41-41 768 5510

The Americas:

Tel: +1-951 781-5500 • Fax: +1-951 781-5700

www.bourns.com

How to Order

SMBJ 5.0 CA

Package _____
SMBJ = SMA/DO-214AA

Working Peak Reverse Voltage _____
5.0 = 5.0 V_{RWM} (Volts)

Suffix _____
A = 5 % Tolerance Unidirectional Device
CA = 5 % Tolerance Bidirectional Device

*RoHS Directive 2002/95/EC Jan 27 2003 including Annex.
Specifications are subject to change without notice.

Customers should verify actual device performance in their specific applications.

SMBJ Transient Voltage Suppressor Diode Series

BOURNS®

Electrical Characteristics (@ $T_A = 25\text{ }^\circ\text{C}$ Unless Otherwise Noted)

Unidirectional Device		Bidirectional Device		Breakdown Voltage V_{BR} (Volts)			Working Peak Reverse Voltage	Maximum Reverse Leakage @ V_{RWM}	Maximum Reverse Voltage @ I_{RSM}	Maximum Reverse Surge Current
Part Number	Part Marking	Part Number	Part Marking	Min.	Max.	@ I_T (mA)	V_{RWM} (Volts)	I_R (μA)	V_{RSM} (Volts)	I_{RSM} (Amps)
SMBJ5.0A	KE	SMBJ5.0CA	AE	6.40	7.25	10	5.0	800	9.2	65.2
SMBJ6.0A	KG	SMBJ6.0CA	AG	6.67	7.67	10	6.0	800	10.3	58.3
SMBJ6.5A	KK	SMBJ6.5CA	AK	7.22	8.30	10	6.5	500	11.2	53.6
SMBJ7.0A	KM	SMBJ7.0CA	AM	7.78	8.95	10	7.0	200	12.0	50.0
SMBJ7.5A	KP	SMBJ7.5CA	AP	8.33	9.58	1.0	7.5	100	12.9	46.5
SMBJ8.0A	KR	SMBJ8.0CA	AR	8.89	10.2	1.0	8.0	50	13.6	44.1
SMBJ8.5A	KT	SMBJ8.5CA	AT	9.44	10.8	1.0	8.5	20	14.4	41.7
SMBJ9.0A	KV	SMBJ9.0CA	AV	10.0	11.5	1.0	9.0	10	15.4	39.0
SMBJ10A	KX	SMBJ10CA	AX	11.1	12.8	1.0	10	5.0	17.0	35.3
SMBJ11A	KZ	SMBJ11CA	AZ	12.2	14.4	1.0	11	5.0	18.2	33.0
SMBJ12A	LE	SMBJ12CA	BE	13.3	15.3	1.0	12	5.0	19.9	30.2
SMBJ13A	LG	SMBJ13CA	BG	14.4	16.5	1.0	13	5.0	21.5	27.9
SMBJ14A	LK	SMBJ14CA	BK	15.6	17.9	1.0	14	5.0	23.2	25.8
SMBJ15A	LM	SMBJ15CA	BM	16.7	19.2	1.0	15	5.0	24.4	24.0
SMBJ16A	LP	SMBJ16CA	BP	17.8	20.5	1.0	16	5.0	26.0	23.1
SMBJ17A	LR	SMBJ17CA	BR	18.9	21.7	1.0	17	5.0	27.6	21.7
SMBJ18A	LT	SMBJ18CA	BT	20.0	23.3	1.0	18	5.0	29.2	20.5
SMBJ20A	LV	SMBJ20CA	BV	22.2	25.5	1.0	20	5.0	32.4	18.5
SMBJ22A	LX	SMBJ22CA	BX	24.4	28.0	1.0	22	5.0	35.5	16.9
SMBJ24A	LZ	SMBJ24CA	BZ	26.7	30.7	1.0	24	5.0	38.9	15.4
SMBJ26A	ME	SMBJ26CA	CE	28.9	32.2	1.0	26	5.0	42.1	14.2
SMBJ28A	MG	SMBJ28CA	CG	31.1	35.8	1.0	28	5.0	45.4	13.2
SMBJ30A	MK	SMBJ30CA	CK	33.3	38.3	1.0	30	5.0	48.4	12.4
SMBJ33A	MM	SMBJ33CA	CM	36.7	42.2	1.0	33	5.0	53.3	11.3
SMBJ36A	MP	SMBJ36CA	CP	40	46.0	1.0	36	5.0	58.1	10.3
SMBJ40A	MR	SMBJ40CA	CR	44.4	51.1	1.0	40	5.0	64.5	9.3
SMBJ43A	MT	SMBJ43CA	CT	47.8	54.9	1.0	43	5.0	69.4	8.6
SMBJ45A	MV	SMBJ45CA	CV	50	57.5	1.0	45	5.0	72.7	8.3
SMBJ48A	MX	SMBJ48CA	CX	53.3	61.3	1.0	48	5.0	77.4	7.7
SMBJ51A	MZ	SMBJ51CA	CZ	56.7	65.2	1.0	51	5.0	82.4	7.3
SMBJ54A	NE	SMBJ54CA	DE	60	69	1.0	54	5.0	87.1	6.9
SMBJ58A	NG	SMBJ58CA	DG	64.4	74.6	1.0	58	5.0	93.6	6.4
SMBJ60A	NK	SMBJ60CA	DK	66.7	76.7	1.0	60	5.0	96.8	6.2
SMBJ64A	NM	SMBJ64CA	DM	71.1	81.8	1.0	64	5.0	103	5.8
SMBJ70A	NP	SMBJ70CA	DP	77.8	89.5	1.0	70	5.0	113	5.3
SMBJ75A	NR	SMBJ75CA	DR	83.3	95.8	1.0	75	5.0	121	4.9
SMBJ78A	NT	SMBJ78CA	DT	86.7	99.7	1.0	78	5.0	126	4.7
SMBJ85A	NV	SMBJ85CA	DV	94.4	109	1.0	85	5.0	137	4.4
SMBJ90A	NX	SMBJ90CA	DX	100	116	1.0	90	5.0	146	4.1
SMBJ100A	NZ	SMBJ100CA	DZ	111	128	1.0	100	5.0	162	3.7
SMBJ110A	PE	SMBJ110CA	EE	122	140	1.0	110	5.0	177	3.4
SMBJ120A	PG	SMBJ120CA	EG	133	153	1.0	120	5.0	193	3.1
SMBJ130A	PK	SMBJ130CA	EK	144	165	1.0	130	5.0	209	2.9
SMBJ150A	PM	SMBJ150CA	EM	167	192	1.0	150	5.0	243	2.5
SMBJ160A	PP	SMBJ160CA	EP	178	205	1.0	160	5.0	259	2.3
SMBJ170A	PR	SMBJ170CA	ER	189	218	1.0	170	5.0	275	2.2

Notes:

- Suffix 'A' denotes a 5 % tolerance unidirectional device.
- Suffix 'CA' denotes a 5 % tolerance bidirectional device.
- For bidirectional devices with a V_R of 10 volts or less, the I_R limit is double.
- For unidirectional devices with a V_F max. of 3.5 V at an I_F of 35 A, 0.5 Sine Wave of 8.3 ms Pulse Width.

Specifications are subject to change without notice.
Customers should verify actual device performance in their specific applications.

SMBJ Transient Voltage Suppressor Diode Series

BOURNS®

Product Dimensions

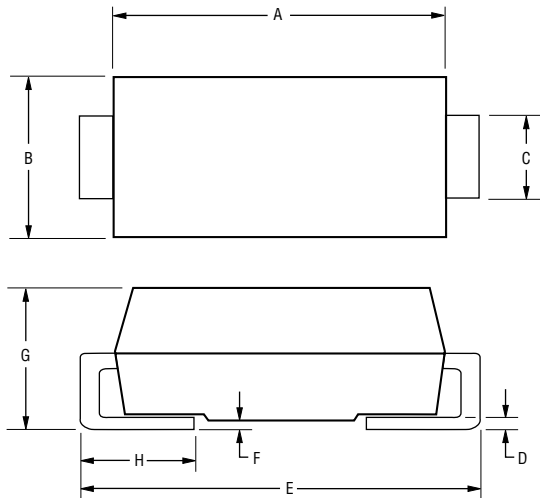

Dimension	SMB (DO-214AA)
A	$\frac{4.06 - 4.57}{(0.160 - 0.180)}$
B	$\frac{3.30 - 3.94}{(0.130 - 0.155)}$
C	$\frac{1.96 - 2.21}{(0.077 - 0.087)}$
D	$\frac{0.15 - 0.31}{(0.006 - 0.112)}$
E	$\frac{5.21 - 5.59}{(0.205 - 0.220)}$
F	$\frac{0.05 - 0.20}{(0.002 - 0.008)}$
G	$\frac{2.01 - 2.62}{(0.080 - 0.103)}$
H	$\frac{0.76 - 1.52}{(0.030 - 0.060)}$

DIMENSIONS: $\frac{\text{MM}}{\text{(INCHES)}}$

Recommended Footprint

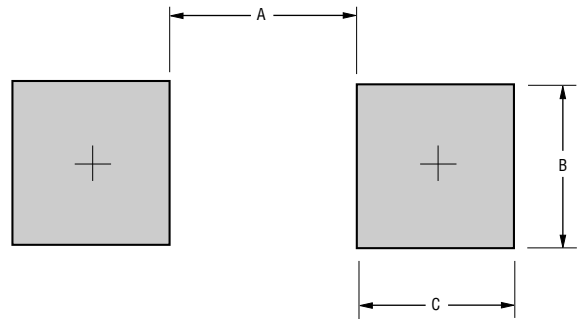

Dimension	SMB (DO-214AA)
A (Max.)	$\frac{2.69}{(0.106)}$
B (Min.)	$\frac{2.10}{(0.083)}$
C (Min.)	$\frac{1.27}{(0.050)}$

DIMENSIONS: $\frac{\text{MM}}{\text{(INCHES)}}$

Physical Specifications

CaseMolded plastic per UL Class 94V-0
 Polarity Cathode band indicates unidirectional device
 No cathode band indicates bidirectional device
 Weight0.003 ounces / 0.093 grams

SMBJ Transient Voltage Suppressor Diode Series



Rating & Characteristic Curves

Pulse Derating Curve

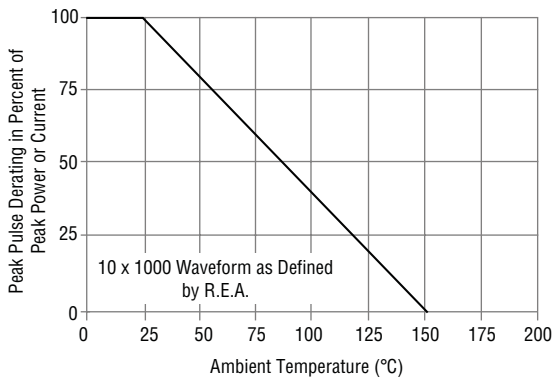

Maximum Non-Repetitive Surge Current

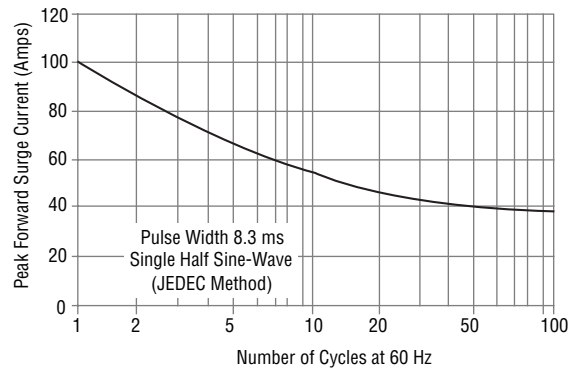

Pulse Waveform

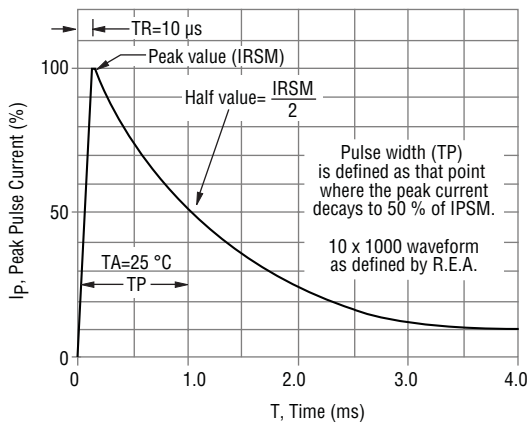

Typical Junction Capacitance

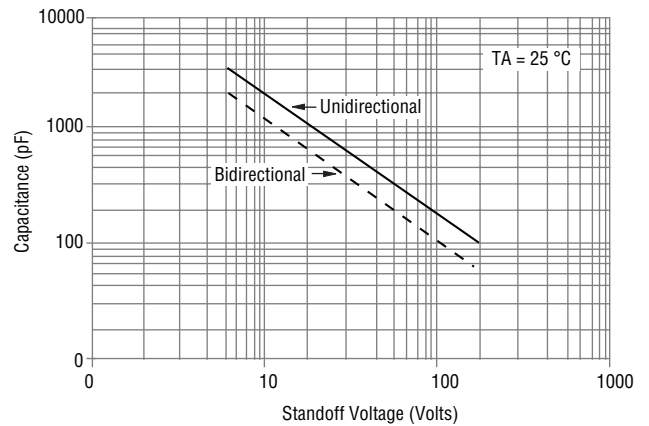

Pulse Rating Curve

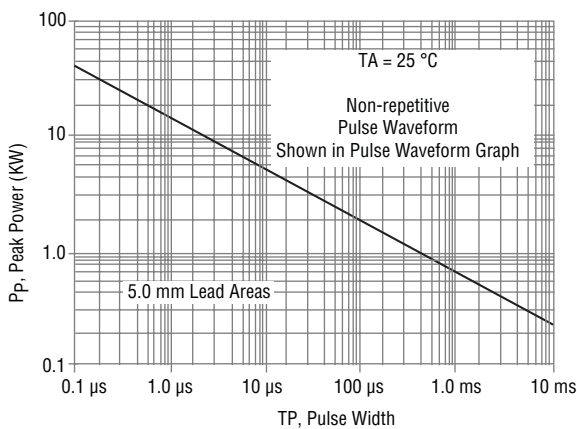

Steady State Power Derating Curve

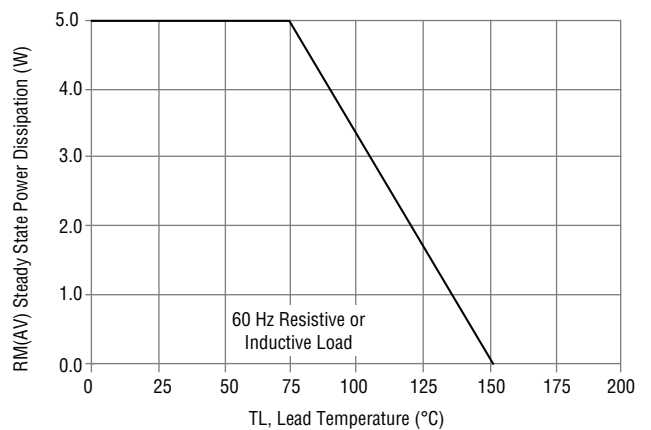

Specifications are subject to change without notice.
Customers should verify actual device performance in their specific applications.

SMBJ Transient Voltage Suppressor Diode Series

BOURNS®

Packaging Information

The product will be dispensed in tape and reel format (see diagram below).

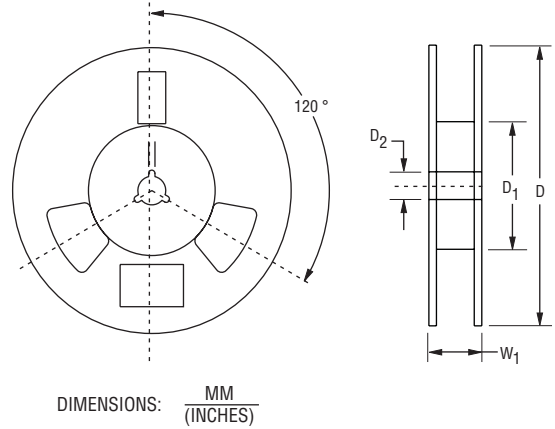
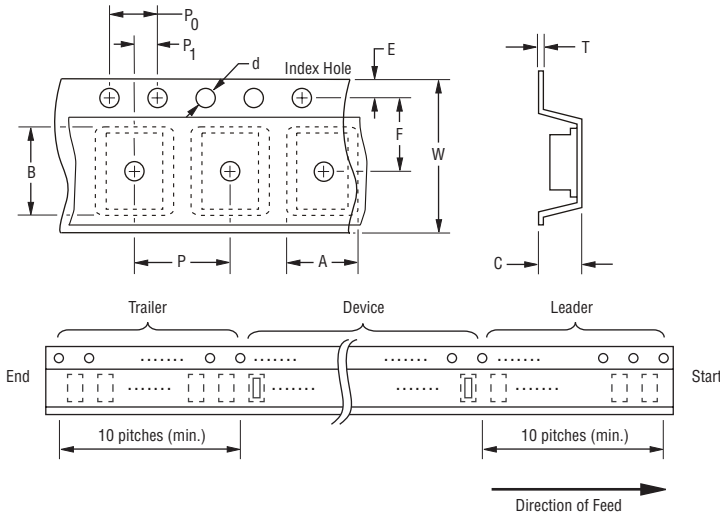

Devices are packed in accordance with EIA standard RS-481-A and specifications shown here.

Item	Symbol	SMB (DO-214AA)
Carrier Width	A	$\frac{4.94 \pm 0.10}{(0.194 - 0.004)}$
Carrier Length	B	$\frac{5.57 \pm 0.10}{(0.210 \pm 0.004)}$
Carrier Depth	C	$\frac{2.36 \pm 0.10}{(0.093 \pm 0.004)}$
Sprocket Hole	d	$\frac{1.55 \pm 0.05}{(0.061 \pm 0.002)}$
Reel Outside Diameter	D	$\frac{330}{(12.992)}$
Reel Inner Diameter	D ₁	$\frac{50.0}{(1.969)}$ MIN.
Feed Hole Diameter	D ₂	$\frac{13.0 \pm 0.20}{(0.512 \pm 0.008)}$
Sprocket Hole Position	E	$\frac{1.75 \pm 0.10}{(0.069 \pm 0.004)}$
Punch Hole Position	F	$\frac{5.50 \pm 0.05}{(0.217 \pm 0.002)}$
Punch Hole Pitch	P	$\frac{4.00 \pm 0.10}{(0.157 \pm 0.004)}$
Sprocket Hole Pitch	P ₀	$\frac{4.00 \pm 0.10}{(0.157 \pm 0.004)}$
Embossment Center	P ₁	$\frac{2.00 \pm 0.05}{(0.079 \pm 0.002)}$
Overall Tape Thickness	T	$\frac{0.30 \pm 0.10}{(0.012 \pm 0.004)}$
Tape Width	W	$\frac{12.00 \pm 0.20}{(0.472 \pm 0.008)}$
Reel Width	W ₁	$\frac{18.4}{(0.724)}$ MAX.
Quantity per Reel	--	3,000