



Features

- RoHS compliant*
- SMC package
- Surface mount
- High current capability

CD214C-B320 ~ B360 Schottky Barrier Rectifier Chip Diode

General Information

The markets of portable communications, computing and video equipment are challenging the semiconductor industry to develop increasingly smaller electronic components.

Bourns offers Schottky Rectifier Diodes for rectification applications, in compact chip package DO-214AB (SMC) size format, which offer PCB real estate savings and are considerably smaller than competitive parts. The Schottky Rectifier Diodes offer a forward current of 3 A with a choice of repetitive peak reverse voltage of 20 V up to 60 V.

Bourns® Chip Diodes conform to JEDEC standards, are easy to handle with standard pick and place equipment and their flat configuration minimizes roll away.

Electrical Characteristics (@ T_A = 25 °C Unless Otherwise Noted)

Parameter	Symbol	CD214C-					Unit
		B320	B330	B340	B350	B360	
Forward Voltage (Max.) (I _f = 3 A)	V _F	0.5	0.5	0.5	0.7	0.7	V
Typical Junction Capacitance*	C _T	250					pF
Reverse Current (Max.) at Rated V _R)	I _R	0.5					mA

* Measured at 1.0 MHz and applied reverse voltage of 4.0 V DC.

Absolute Ratings (@ T_A = 25 °C Unless Otherwise Noted)

Parameter	Symbol	CD214C-					Unit
		B320	B330	B340	B350	B360	
Repetitive Peak Reverse Voltage	V _{RRM}	20	30	40	50	60	V
Reverse Voltage	V _R	20	30	40	50	60	V
Maximum RMS Voltage	V _{RMS}	14	21	28	35	42	V
Avg. Forward Current	I _O	3					A
Forward Current, Surge Peak (60 Hz, 1 cycle)	I _{surge}	100					A
Typical Thermal Resistance**	R _{θJL}	10					°C/W
Storage Temperature	T _{STG}	-55 to +150					°C
Junction Temperature	T _J	-55 to +125					°C

** Thermal resistance junction to lead.

How To Order

CD 214C - B 3 30 LF

Common Code _____
Chip Diode

Package _____
• 214C = SMC/DO-214AB

Model _____
B = Schottky Barrier Series

Average Forward Current (I_O) Code _____
3 = 3 A (Code x 1000 mA = Average Forward Current)

Reverse Voltage (V_R) Code _____
30 = 30 V
40 = 40 V
60 = 60 V

Terminations _____
LF = 100 % Sn (RoHS Compliant)

*RoHS Directive 2002/95/EC Jan 27, 2003 including Annex.
Specifications are subject to change without notice.
Customers should verify actual device performance in their specific applications.

CD214C-B320 ~ B360 Schottky Barrier Rectifier Chip Diode



Product Dimensions

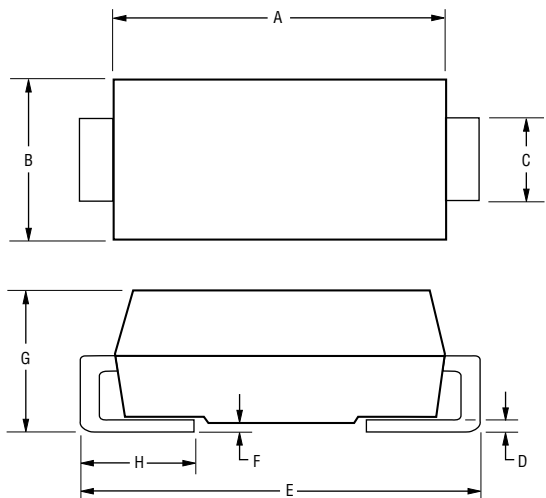

Dimension	SMC (DO-214AB)
A	$\frac{6.60 - 7.11}{(0.260 - 0.280)}$
B	$\frac{5.59 - 6.22}{(0.220 - 0.245)}$
C	$\frac{2.92 - 3.18}{(0.115 - 0.125)}$
D	$\frac{0.15 - 0.31}{(0.006 - 0.112)}$
E	$\frac{7.75 - 8.13}{(0.305 - 0.320)}$
F	$\frac{0.05 - 0.20}{(0.002 - 0.008)}$
G	$\frac{2.01 - 2.62}{(0.080 - 0.103)}$
H	$\frac{0.76 - 1.52}{(0.030 - 0.060)}$

DIMENSIONS: $\frac{\text{MM}}{\text{(INCHES)}}$

Recommended Pad Layout

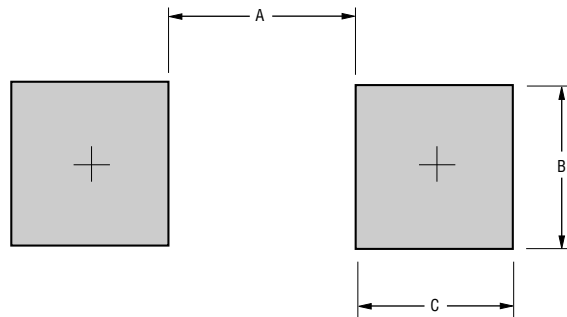

Dimension	SMC (DO-214AB)
A (Max.)	$\frac{4.69}{(0.185)}$
B (Min.)	$\frac{3.07}{(0.121)}$
C (Min.)	$\frac{1.52}{(0.060)}$

DIMENSIONS: $\frac{\text{MM}}{\text{(INCHES)}}$

Physical Specifications

CaseMolded plastic
 PolarityIndicated by cathode band
 Weight0.007 ounces / 0.21 grams

Typical Part Marking

CD214C-B320 **B** 320
 CD214C-B330 **B** 330
 CD214C-B340 **B** 340
 CD214C-B350 **B** 350
 CD214C-B360 **B** 360

CD214C-B320 ~ B360 Schottky Barrier Rectifier Chip Diode



Rating and Characteristic Curves

Forward Current Derating Curve

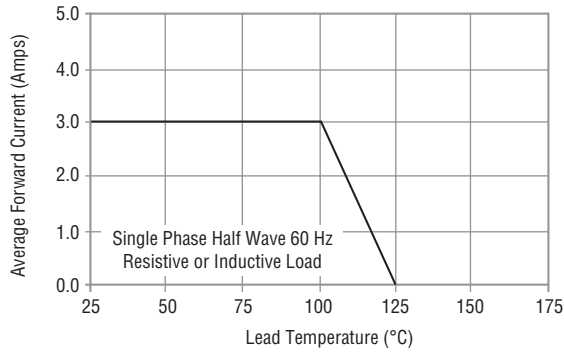

Maximum Non-Repetitive Surge Current

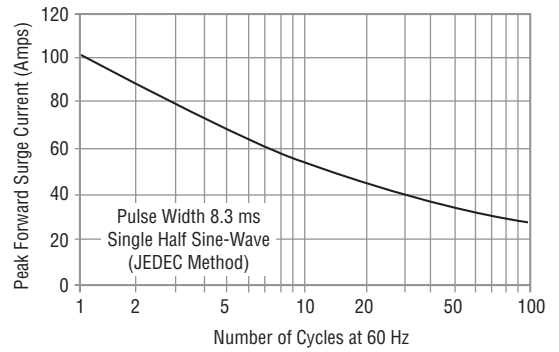

Typical Forward Characteristics

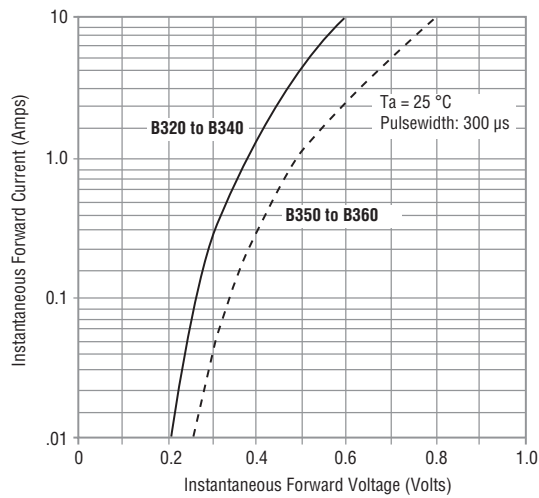

Typical Junction Capacitance

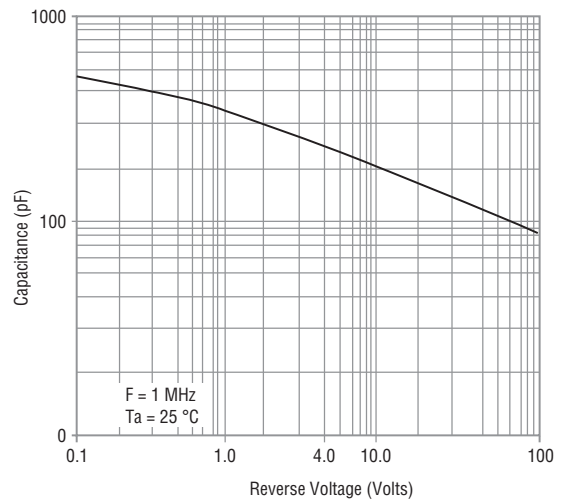

Typical Reverse Characteristics

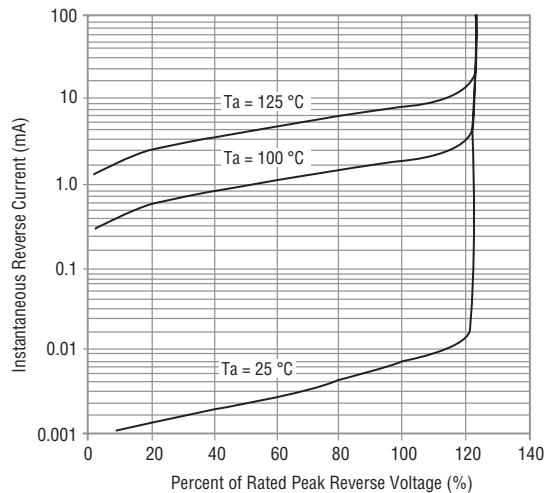

Specifications are subject to change without notice.
Customers should verify actual device performance in their specific applications.

CD214C-B320 ~ B360 Schottky Barrier Rectifier Chip Diode

BOURNS®

Packaging Information

The product will be dispensed in Tape and Reel format (see diagram below).

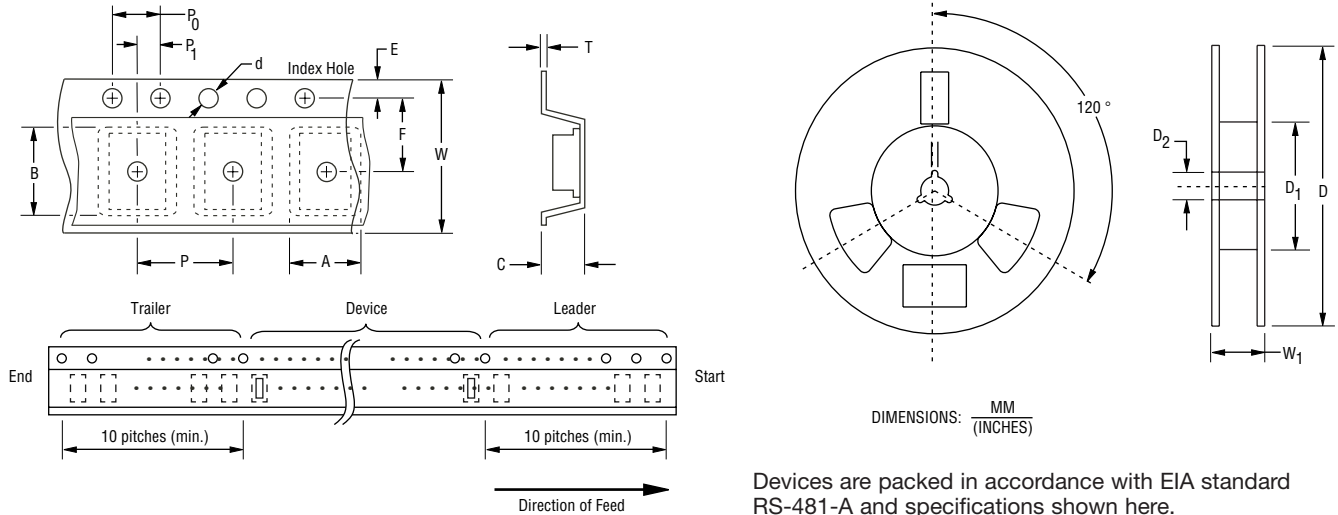

Devices are packed in accordance with EIA standard RS-481-A and specifications shown here.

Item	Symbol	SMC (DO-214AB)
Carrier Width	A	$\frac{7.22 \pm 0.10}{(0.284 - 0.004)}$
Carrier Length	B	$\frac{8.11 \pm 0.10}{(0.319 - 0.004)}$
Carrier Depth	C	$\frac{2.36 \pm 0.10}{(0.093 - 0.004)}$
Sprocket Hole	d	$\frac{1.55 \pm 0.05}{(0.061 - 0.002)}$
Reel Outside Diameter	D	$\frac{330}{(12.992)}$
Reel Inner Diameter	D ₁	$\frac{50.0}{(1.969)}$ MIN.
Feed Hole Diameter	D ₂	$\frac{13.0 \pm 0.20}{(0.512 - 0.008)}$
Sprocket Hole Position	E	$\frac{1.75 \pm 0.10}{(0.069 - 0.004)}$
Punch Hole Position	F	$\frac{7.50 \pm 0.10}{(0.295 - 0.004)}$
Punch Hole Pitch	P	$\frac{4.00 \pm 0.10}{(0.157 - 0.004)}$
Sprocket Hole Pitch	P ₀	$\frac{4.00 \pm 0.10}{(0.157 - 0.004)}$
Embossment Center	P ₁	$\frac{2.00 \pm 0.10}{(0.079 - 0.004)}$
Overall Tape Thickness	T	$\frac{0.30 \pm 0.10}{(0.012 - 0.004)}$
Tape Width	W	$\frac{16.00 \pm 0.20}{(0.630 - 0.008)}$
Reel Width	W ₁	$\frac{22.4}{(0.882)}$ MAX.
Quantity per Reel	--	3,000